



TAMADEX[®]

spol. s. r. o.

Výroba a prodej kovových prvků pro sádkokartonové systémy

Production of metal parts for drywall systems

Katalog produktů

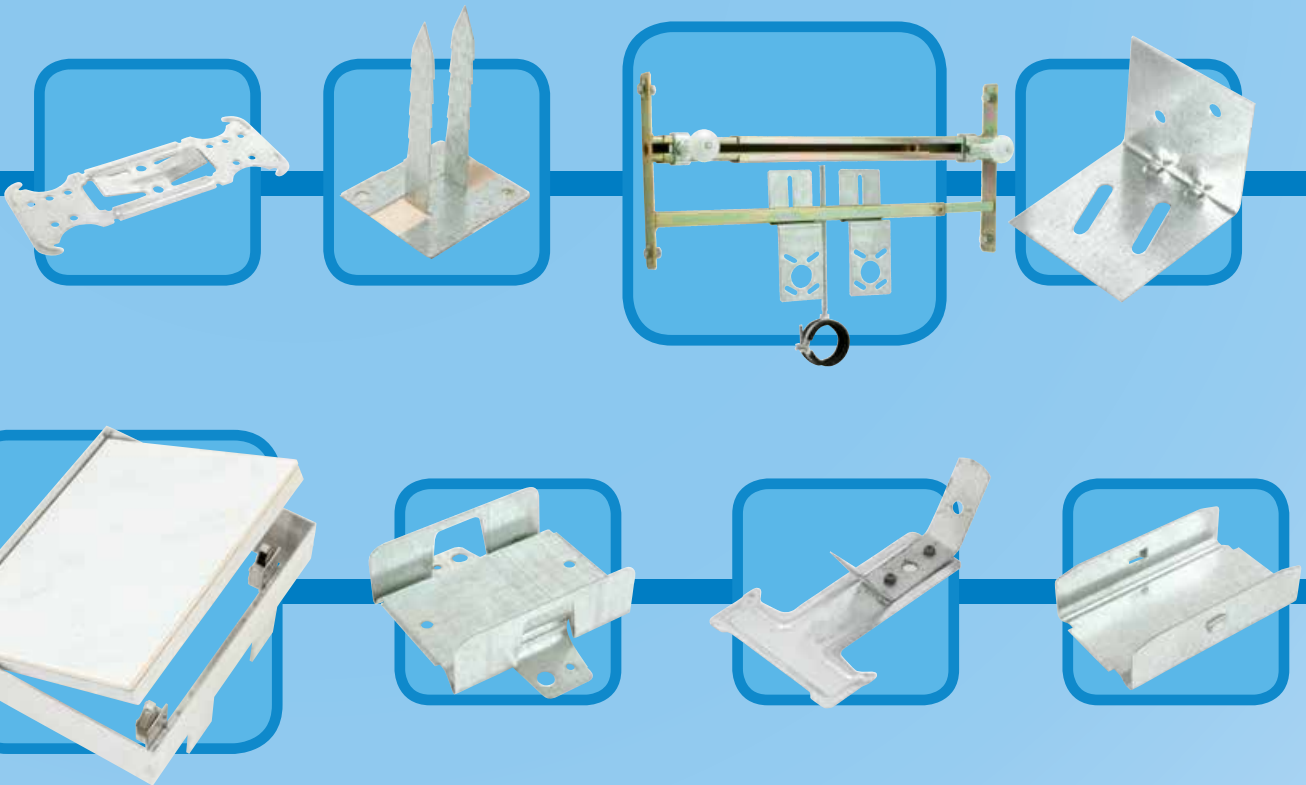

ISO 9001:2008



www.tamadex.cz

TAMADEX je tradičním tuzemským výrobcem a dodavatelem, vyvážíme však i do evropských zemí.

TAMADEX is traditional manufacturer and supplier on domestic market, but we do export also to many European countries.

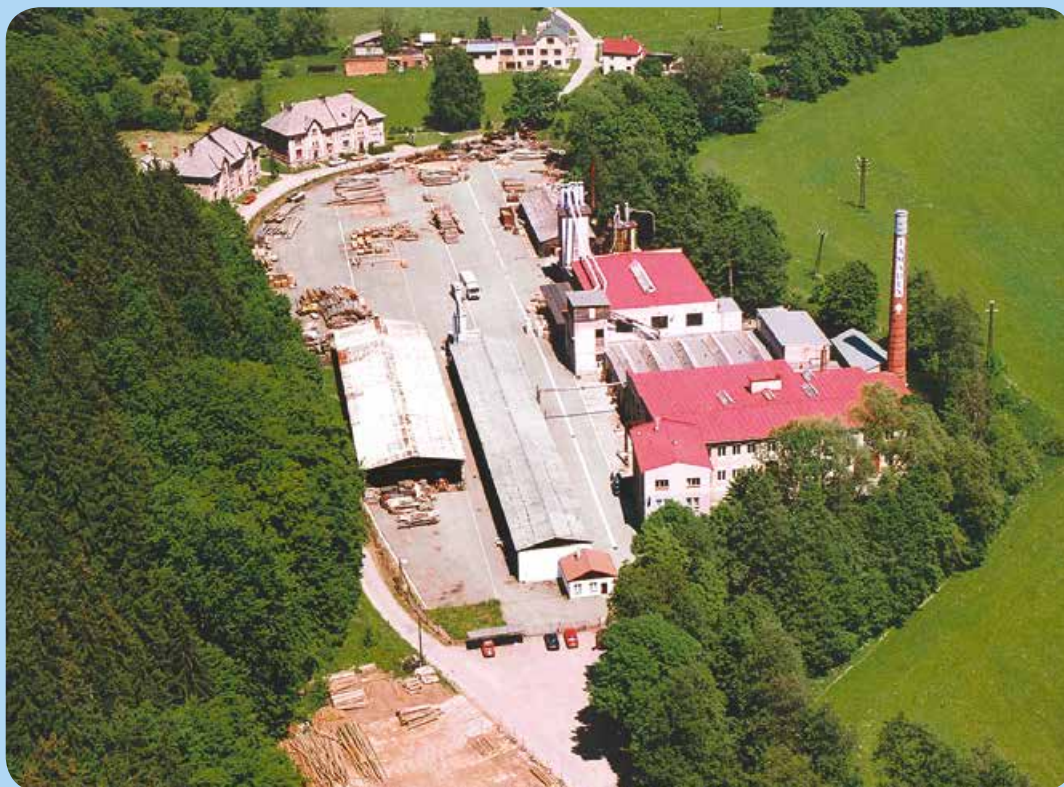
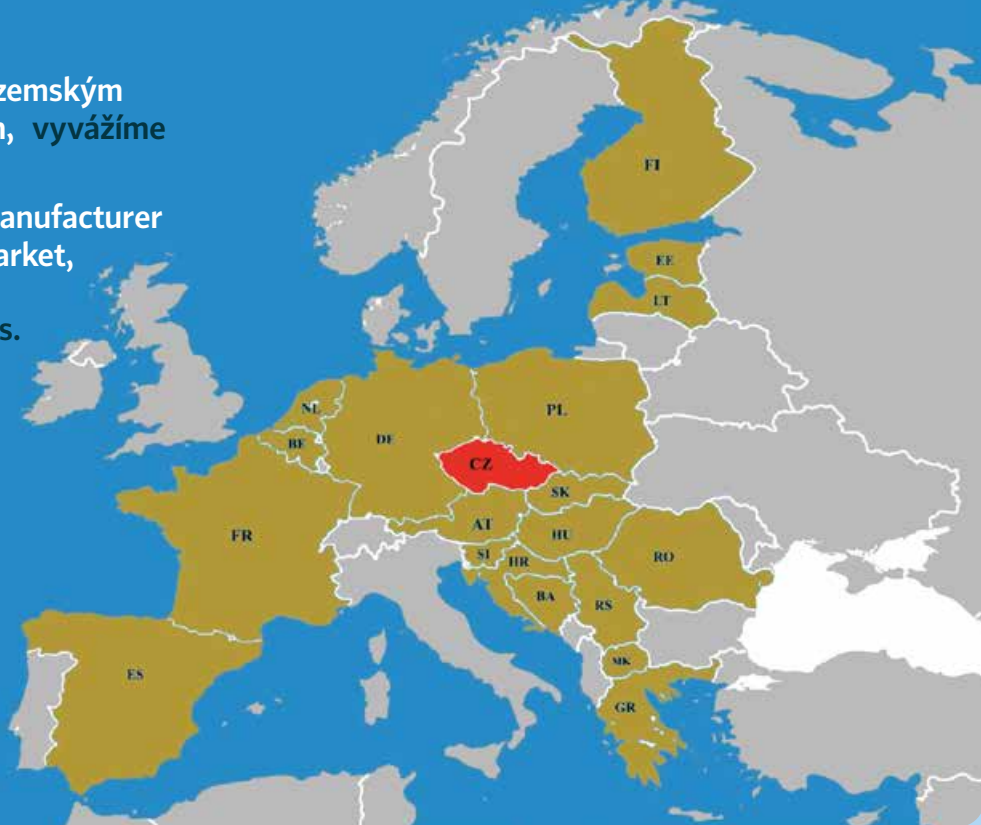

Historie: Firma byla založena v roce 1990 jako fyzická společnost (konsorcium) s názvem TAMADEX, zabývající se kovovými výrobami, zejména lisařskými pracemi s kooperací kovových výlisků pro české a zahraniční společnosti. V roce 1992 začala další výroba pro energetiku a koncem roku 1993 byl rozšířen výrobní program o upevňovací techniku pro instalační potřeby. Od roku 1994 je z dalších výrobních programů firmy – výroba kovových prvků do sádkartonových konstrukcí. V roce 2000 vzniká společnost TAMADEX, spol. s r. o., která navázala na činnost fyzické firmy TAMADEX. V současné době se soustředíme na výrobu nástrojů, elektroerozivní a CNC obrábění, lisařské práce, montáže výrobků, výrobu revizních dvířek, kovových prvků pro sádkartonové systémy a expedice.

History: Company was established in 1990 like consortium with name TAMADEX dealing with metalworking, especially pressing works with co-operate metal pressing pieces for Czech and foreign companies. In 1992 started new production for energetics. In the ending of 1993 was extended production program for fixing components for plumbers. Since 1994 we started new production program- metal components for drywall system. TAMADEX, spol s r. o. (Ltd) was found in the 2000 to followed activity of consortium TAMADEX. Next we focus at production of dietools, electroerosion and CNC machining, pressing works, assembling of product and production of inspection doors both for drywall and masonry construction.

OBSAH

contents

kovové spojovací prvky metal connecting parts	2
kovové spojovací prvky RG metal connecting parts	12
sanitární program sanitary facilities	14
Revizní dvířka do sádkartonových a zděných systémů inspection doors for drywall systems and for masonry	16
Profily a lišty profiles and laths	24
Hmoždinky a spojovací materiál dowels, fixing and jointing material	26
Prvky pro zateplení Accessories for facade insulation	31
Omítky Plasters	34
Pásky a tmely tapes and binder	35
Dlažba paving	38
Nářadí tools	39

Přímý závěs
CD bracket

ks/pcs

1.348100T	60/125 – 0,8 mm	100
-----------	-----------------	-----

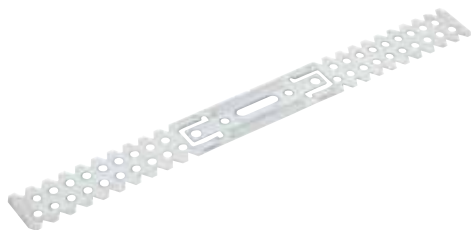

Přímý závěs
CD bracket

ks/pcs

1.348101T	60/125 – 1 mm	100
1.348101.200T	60/200 – 1 mm	50
1.348101.250T	60/250 – 1 mm	50
1.348101.300T	60/300 – 1 mm	50

Možnost výroby různé délky od 150 mm.
Optional production of any length over 150 mm.



Stavěcí třmen
Adjusting rocker bar

ks/pcs

1.348105.120	Stavěcí třmen 120 mm	25
1.348105.150	Stavěcí třmen 150 mm	25
1.348105.170	Stavěcí třmen 170 mm	25
1.348105.200	Stavěcí třmen 200 mm	25
1.348105.250	Stavěcí třmen 250 mm	25
1.348105.300	Stavěcí třmen 300 mm	25
1.348105.350	Stavěcí třmen 350 mm	25
1.348105.400	Stavěcí třmen 400 mm	25
1.348105.450	Stavěcí třmen 450 mm	25
1.348105.500	Stavěcí třmen 500 mm	25

Možnost výroby různé délky.
Optional production of any length.



Přímý závěs
CD bracket

ks/pcs

1.348102T	60/55 mm	100
-----------	----------	-----



Posuvný závěs CD plochý – T
Movable flat hanger for CD – T

ks/pcs

1.348106T		100
-----------	--	-----



Stavěcí třmen
Adjusting rocker bar

ks/pcs

1.348103T	35 mm	100
1.348104T	65 mm	100
1.348105T	95 mm	100

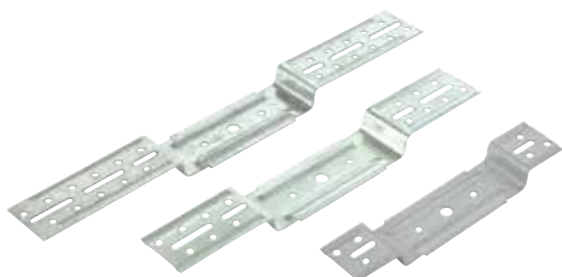

Závěs CD krokový T
CD hanger

ks/pcs

1.348107T	150 mm	100
1.348107.03T	170 mm	100



Závěs CD krokrový N
CD hanger – half-rounded

ks/pcs

1.348107.2T	170 mm	100
-------------	--------	-----



Závěs CD krokrový N
CD hanger – half-rounded

ks/pcs

1.348107.3T	270 mm	100
-------------	--------	-----



Prodloužený závěs krokrový
CD hanger extended

ks/pcs

1.348108T	200 mm	100
1.348109T	250 mm	100
1.348109,3T	300 mm	100
1.348109,4T	350 mm	100
1.348109,5T	400 mm	100
1.348109,6T	450 mm	100
1.348109,7T	500 mm	100



Drát s okem

Suspension wire with eyelet

ks/pcs

1.348130T	125 mm	100
1.348131T	250 mm	100
1.348132T	375 mm	100
1.348133T	500 mm	100
1.348134T	750 mm	100
1.348135T	1000 mm	100
1.348136T	1200 mm	100
1.348137T	1500 mm	100
1.348138T	2000 mm	100

Možnost výroby různé délky.
Optional production of any length.



Drát s hákem

Suspension wire with hook

ks/pcs

1.348139T	125 mm	100
1.348140T	250 mm	100
1.348141T	375 mm	100
1.348142T	500 mm	100
1.348143T	750 mm	100
1.348144T	1000 mm	100
1.348145T	1200 mm	100
1.348146T	1500 mm	100
1.348147T	2000 mm	100

Možnost výroby různé délky.
Optional production of any length.



Závěs krokový zaoblený – štěrbinový
CD hanger half-rounded

ks/pcs

1.348109,2	200 mm	100
1.348109,3	250 mm	100
1.348109,4	300 mm	100
1.348109,5	350 mm	100
1.348109,6	400 mm	100
1.348109,7	450 mm	100
1.348109,8	500 mm	100



Rychlozávěs pérový
Quick hanger bracket

ks/pcs

1.348114T	100
-----------	-----



Rychlozávěs pérový zaoblený
Quick hanger bracket half-rounded

ks/pcs

1.348115T	100
-----------	-----



Závěs CD krokový zaoblený
CD hanger half-rounded

ks/pcs

1.348110T	170 mm	100
1.348110.1T	150 mm	100
1.348111T	120 mm	100
1.348112T	90 mm	100



Rychlozávěs pérový se zajištěním
Quick hanger bracket with lock

ks/pcs

1.348115T/2	100
-------------	-----



Úhlová kotva
Angle bracket

ks/pcs

1.348113T	100
-----------	-----



Rychlozávěs pérový pro dřevo
Quick hanger for wood

ks/pcs

1.348116T	100
-----------	-----



Pérový závěs pro hlavní T profil – Sah 10
Quick hanger for main runners

1.348117T 100 ks/pcs

Pérový závěs pro hlavní T profil – Armstrong
Quick hanger for main runners

1.348117T/A 100 ks/pcs



Křížová spojka ohnutá
CD cross connection bracket bended

1.348121T 100 ks/pcs

1.348121 N/T 100



1.348121T



1.348121 N/T

Rychlozávěs CD pérový čtyřbodový K 05
Quick hanger bracket 4-pointer

1.348118T 100 ks/pcs



Spojovací kus pro CD
CD section connector

1.348122T 100 mm 100 ks/pcs

1.348122.1T 80 mm 100



Pružinový závěs CD profilu-SSC 100
Quick hanger on spring

1.348119T 100 ks/pcs



Spojovací kus pro CD prohnutý
CD section arch connector

1.348123T 100 ks/pcs



Křížová spojka rovná
CD cross connection bracket straight

1.348120T 100 ks/pcs

1.348120 N/T 100



1.348120T

1.348120 N/T

Jezdec CD profilu
CD profile runner

1.348124T 100 ks/pcs



Spojka CD úrovňová NVB 0100 V
CD level connector

ks/pcs

1.348125TV

100



Dvojitá pérová svorka
Butterfly clip-double spring

ks/pcs

1.348128T

100



Spojka CD úrovňová – 4 bodová
CD level connector – 4-pointer

ks/pcs

1.348125.1T

100



Pérko minerál
Spring for ceiling cassettes

ks/pcs

1.348128.2T

20 – pro desku 15 mm

100

1.348128.3T

25 – pro desku 12,5 mm

100



Přichytná svorka
Suspension clamp

ks/pcs

1.348126T

32 mm

100

1.348126/1T

50 mm

100

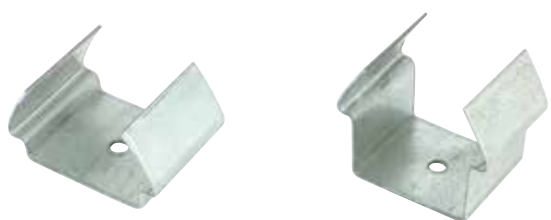

Závěs minerálního podhledu – SHUT 0100
Spring with wire for main runners

ks/pcs

1.348129T

100



Pendex
Pendex hanger-self adhesive

ks/pcs

1.348127T

100



Speciální držák pro opláštění oceli
Special holder for steel sheeting

ks/pcs

1.348129.1T

50



Svorka nosníku
 Beam clamp

ks/pcs

1.348148T	50–85 mm	100
1.348149T	85–130 mm	100
1.348150T	130–210 mm	100

Nonius spodní díl
 Nonius bottom part

ks/pcs

1.348159T	135mm	100
-----------	-------	-----

Svorka nosníku boční
 Hammer clip for beam

ks/pcs

1.348150,1T BOČ	4–10 mm	100
-----------------	---------	-----

Nonius spodní díl pro T profil
 Nonius bottom part for main runners

ks/pcs

1.348160T		100
-----------	--	-----

Nonius vrchní díl
 Nonius hanger upper part

ks/pcs

1.348151T	240 mm	100
1.348152T	340 mm	100
1.348153T	440 mm	50
1.348154T	540 mm	50
1.348155T	640 mm	50
1.348156T	740 mm	50
1.348157T	840 mm	50
1.348158T	940 mm	50

Možnost výroby různé délky.
 Optional production of any length..

Nonius spodní díl pro dřevo
 Nonius bottom part for wood

ks/pcs

1.348161T		100
-----------	--	-----

Nonius CD čtyřbodový – spodní
 Nonius bottom part 4-pointer

ks/pcs

1.348162T		100
-----------	--	-----



Nonius pojistná závlačka

Nonius cotter

ks/pcs

1.348163T

100



Závěsný kolík TA 91350

Hanger peg

ks/pcs

1.348164T

250



Propojovací úhelník

Connecting angle

ks/pcs

1.348165T

UA 50

100

1.348166T

UA 75

100

1.348167T

UA 100

100



Propojovací úhelník – SADA

Connecting angle – set

ks/pcs

Sada obsahuje:

1.348165 SADA

UA 50 sada

8 ks – NH 8x60; 4 ks – podložka M8; 4 ks – šroub M8x16

4 ks – matka M8; 4 ks – úhelník

1.348166 SADA

UA75 sada

8 ks – NH 8x60; 8 ks – podložka M8; 8 ks – šroub M8x16

8 ks – matka M8; 4 ks – úhelník

1.348167 SADA

UA100 sada

8 ks – NH 8x60; 8 ks – podložka M8; 8 ks – šroub M8x16

8 ks – matka M8; 4 ks – úhelník



Spojka CD UA50 – křížová

CD/UA 50 cross connector

ks/pcs

1.348167.1T

50



Přímý závěs na dřevo

Hanger for wooden lath

ks/pcs

1.348169T

50/125/0,8

100

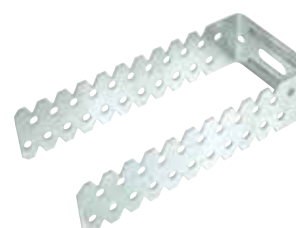

Závěs na T profil – pevný
Direct hanger for the main runner

ks/pcs

1.348172 T	Závěs na T profil pevný – 46,4mm	100
1.348172.1 T	Závěs na T profil pevný – 56,4mm	100
1.348172.2 T	Závěs na T profil pevný – 76,4mm	100
1.348172.3 T	Závěs na T profil pevný – 96,4mm	100



Posuvný závěs CD čtyřbodový
Movable hanger CD four pointer

ks/pcs

1.348171T		100
-----------	--	-----



Nonius spodní díl s perem
Nonius bottom part with spring

ks/pcs

1.348159,2 T	135 mm	100
--------------	--------	-----



Ochranný roh sádkkartonu
Corner protection for plasterboards

ks/pcs

1.348168T		100
-----------	--	-----



Nonius třmen pro UA 50/40
Nonius hanger for UA 50 /40

ks/pcs

1.348163.12T		100
--------------	--	-----



Stěnová spona
Wall clasp

ks/pcs

1.348170T		100
-----------	--	-----



Spona příčné spáry R111
Clip R111 for transverse joint

ks/pcs

1.348181 T		100
------------	--	-----



Křížová spojka rovná
CD cross connection bracket straight

ks/pcs

1.348120 T15

15



Přímý závěs 60/125 - 0.80 m
CD bracket

ks/pcs

1.348100 T15

15



Spojovací kus pro CD prohnutý
CD section arch connector

ks/pcs

1.348123 T15

15



Závěs CD krokrový-N 170 mm
CD hanger - half-rounded

ks/pcs

1.348107.2T1

15



Drát s okem 250 mm
Suspension wire with eyelet

ks/pcs

1.348131 T15

15



Závěs CD krokrový-N 270 mm
CD hanger - half-rounded

ks/pcs

1.348107.3 T15

15



Rychlozávěs pérový zaoblený
Quick hanger bracket half-rounded

ks/pcs

1.348115 T15

15



Stavěcí třmen 65 mm
Adjusting rocker bar 65 mm

ks/pcs

1.348104 T15

15

**Stavěcí třmen 95 mm**
Adjusting rocker bar 95 mm

ks/pcs

1.348105 T15

15



Poznámky:

Přímý závěs RG
RG GL9 bracket

ks/pcs

1.348200T	130 mm	100
-----------	--------	-----



Závěs nonius RG
Nonius bracket RG

ks/pcs

1.348203T		100
-----------	--	-----



Stavěcí třmen RG
Adjusting rocker bar RG

ks/pcs

1.348200.1T	95 mm	100
1.348200.2T	140 mm	100

Možnost výroby různé délky.
Optional production of any length.



Závěs RG
RG hanger

ks/pcs

1.348204T	170 mm	100
-----------	--------	-----



Přímý závěs RG
RG GL2 bracket

ks/pcs

1.348201T	75 mm	100
-----------	-------	-----



Závěs RG
RG hanger

ks/pcs

1.348205T	80 mm	100
-----------	-------	-----



Závěs s perem RG
Quick hanger bracket RG

ks/pcs

1.348202T		100
-----------	--	-----

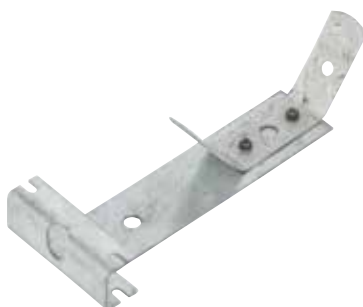

Spojka profilu RG
RG channel connector GL3

ks/pcs

1.348206T		100
-----------	--	-----

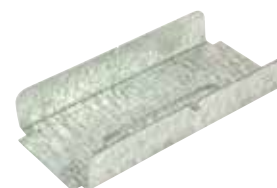

Závěs RG Ciplaine
RG hanger ciplaine

ks/pcs

1.348207T

300 mm

100

**Závěs dvojitý Cavalier RG**
Double RG hanger Cavalier

ks/pcs

1.348208T

100

**Poznámky:**

**Konstrukce pro uchycení umyvadla
se stojánkovou baterií**
Construction for basin+piping

1.348300T RKU - 2 ks/pc 1

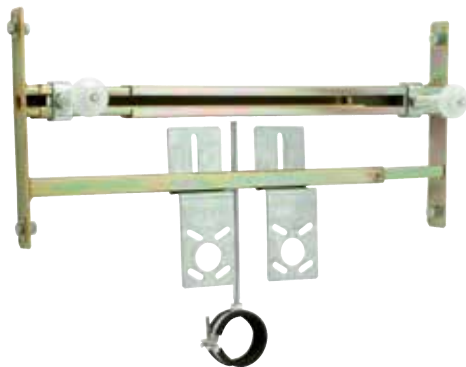

Konstrukce pro uchycení potrubí
Construction for pipe

		ks/pc
1.348303T	RKO - 40	1
1.348304T	RKO - 50	1
1.348305T	RKO - 63	1
1.348306T	RKO - 70	1
1.348307T	RKO - 90/110	1



**Konstrukce pro uchycení umyvadla s
vrchní baterií**
Construction for basin

1.348301T RKU - 1 ks/pc 1

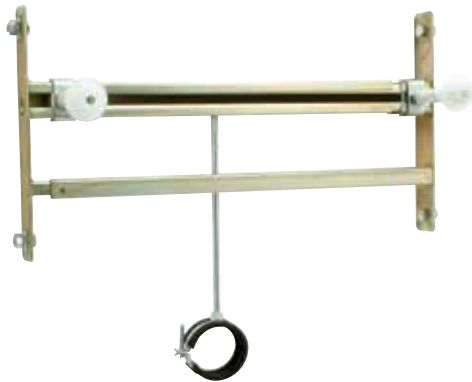

Konstrukce pro uchycení baterie
Construction for fitting double faucet

1.348308T RKB - 1 ks/pc 1

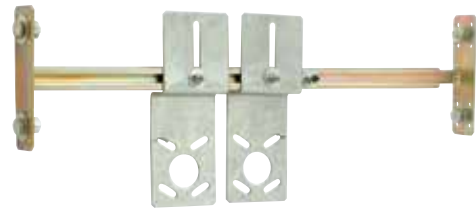

Konstrukce pro uchycení pisoáru
Construction for pissoir

1.348302T RKP - 1 ks/pc 1



Konstrukce pro uchycení kohoutu
Construction for fitting tap

1.348309T RKB - 2 ks/pc 1

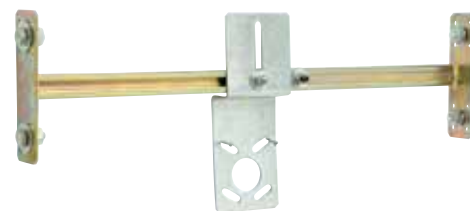

Konstrukce pro uchycení baterie a potrubí
Construction for fitting double faucet + piping

ks/pc

1.348310T	RKBO - 1	1
-----------	----------	---

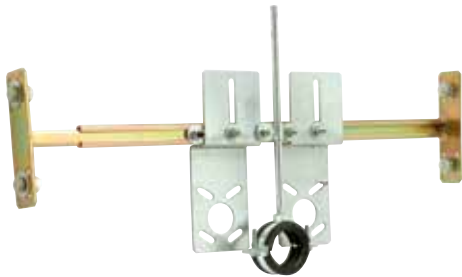

Jádromodul A102

Compactmodul A102 – system for drywall

ks/pc

1.348314T	stavební výška 850 mm	1
1.348314.1T	stavební výška 1000 mm	1
1.348314.2T	stavební výška 1200 mm	1



Konstrukce pro uchycení WC
Construction for toilet

ks/pc

1.348311T	RKWC	1
-----------	------	---

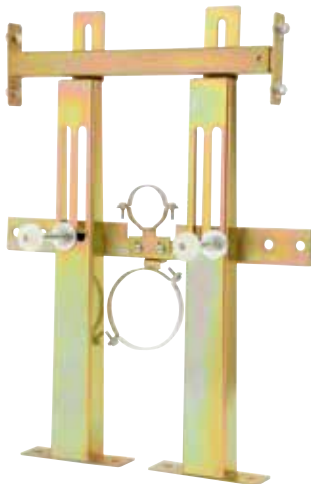

Konstrukce pro uchycení bidetu
Construction for toilet or bidet

ks/pc

1.348312T	RKWC – bidet	1
-----------	--------------	---

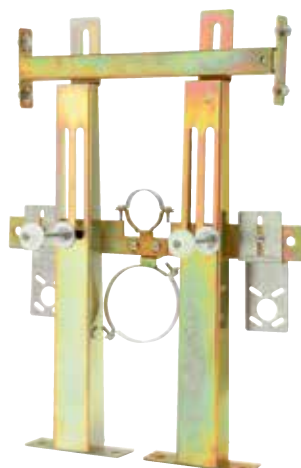

Držák boiler, radiátor

Construction for boiler, radiator

ks/pc

1.348315T		1
-----------	--	---



Revizní dvířka se zámkem CZ tl. 12,5 mm – GKB
Revision door spring lock 12,5 mm

1.348400T/NZ	200x200 mm
1.348401T/NZ	300x300 mm
1.348402T/NZ	400x400 mm
1.348403T/NZ	500x500 mm
1.348404T/NZ	600x600 mm



Revizní dvířka se speciálním US zámkem tl. 12,5 mm – GKB
Revision door SP lock 12,5 mm

1.348405T/SZ	200x200 mm
1.348406T/SZ	300x300 mm
1.348407T/SZ	400x400 mm
1.348408T/SZ	500x500 mm
1.348409T/SZ	600x600 mm



Revizní dvířka SOFTLINE plechová bílá, zámek klička
Revision door SOFTLINE, metal white

1.348430,2 20R	200x200 mm
1.348430,3R	300x300 mm
1.348430,4R	400x400 mm
1.348430,5R	500x500 mm
1.348430,6R	600x600 mm



Revizní dvířka SOFTLINE plechová bílá, zámek US
Revision door SOFTLINE, metal white, SP lock

1.348430,2 20T	200x200 mm
1.348430,3T	300x300 mm
1.348430,4T	400x400 mm
1.348430,5T	500x500 mm
1.348430,6T	600x600 mm



Revizní dvířka zámek CZ tl. 15 mm – GKB
Revision door 15 mm, spring lock

1.348411.0T	200x200 mm
1.348411.01T	300x300 mm
1.348411.02T	400x400 mm
1.348411.03T	500x500 mm
1.348411.04T	600x600 mm



Revizní dvířka zámek US tl. 15 mm – GKB
Revision door 15 mm, SP lock

1.348412.0T	200x200 mm
1.348412.01T	300x300 mm
1.348412.02T	400x400 mm
1.348412.03T	500x500 mm
1.348412.04T	600x600 mm



**Revizní dvířka protipožární tl. 25 mm (s kličkou)
 – požární odolnost EI30D1**
Revision door with crank 25 mm – fire resistance EI 30 D1

1.348415T/JZ	200x200 mm
1.348416T/JZ	300x300 mm
1.348417T/JZ	400x400 mm
1.348418T/JZ	500x500 mm
1.348419T/JZ	600x600 mm

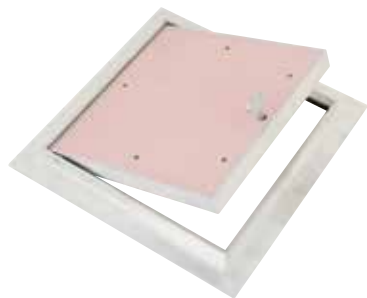
Revizní dvířka do zdiva – zámek US – GKB
inspections doors for masonry, SP locks

1.348425.2 US/Z	200x200 mm
1.348425.3 US/Z	300x300 mm
1.348425.4 US/Z	400x400 mm
1.348425.5 US/Z	500x500 mm
1.348425.6 US/Z	600x600 mm

Revizní dvířka prachotěsná zámek US tl. 12,5 mm – GKB
dustproof inspection doors, SP locks

1.348420 US/TS	200x200 mm
1.348420,1 US/TS	300x300 mm
1.348420,2 US/TS	400x400 mm
1.348420,5 US/TS	500x500 mm
1.348420,6 US/TS	600x600 mm

Revizní dvířka uzamykatelná – FAB, tl. 12,5 mm – GKB
lockable inspection doors, cylindric lock

1.348421 FAB	200x200 mm
1.348421.1 FAB	300x300 mm
1.348421.2 FAB	400x400 mm
1.348421.3 FAB	500x500 mm
1.348421.4 FAB	600x600 mm

**Revizní dvířka prachotěsná do zdiva tl. 12,5 mm
 zámek US – GKB**
dustproof inspection doors for masonry

1.348425,2 US/ZT	200x200 mm
1.348425,3 US/ZT	300x300 mm
1.348425,4 US/ZT	400x400 mm
1.348425,5 US/ZT	500x500 mm
1.348425,6 US/ZT	600x600 mm

Poznámky:

Revizní dvířka akustická – 31 dB/tl. 12,5 mm/zámek US
Acoustic inspection doors – 31 dB attenuation, SP locks

1.348422 A/US	200x200 mm
1.348422.1 A/US	300x300 mm
1.348422.2 A/US	400x400 mm
1.348422.3 A/US	500x500 mm
1.348422.4 A/US	600x600 mm



Revizní dvířka akustická – 34 dB/tl. 25 mm/zámek klíčka
Acoustic inspection doors – 34 dB attenuation, SP locks

1.348423 A/JZ	200x200 mm
1.348423.1 A/JZ	300x300 mm
1.348423.2 A/JZ	400x400 mm
1.348423.3 A/JZ	500x500 mm
1.348423.4 A/JZ	600x600 mm



MOŽNOSTI DALŠÍ VÝROBY / Another production possibilities.

Revizní dvířka vyndávací
Removable inspection doors

Výroba od jakéhokoliv rozměru.
Možnost provedení i do zdiva – 4x zámek US.
Possible for any dimensions, incl. for masonry.



Revizní dvířka dvoukřídlá – zámky US
Double-winged inspection doors

Výroba od větších rozměrů.
– po otevření bez dělicí příčky
– možnost výroby i s dělicí příčkou
*Suitable for bigger sizes.
Could be produced with or without the middle partition.*



Revizní dvířka pod obklad do zdiva
Inspection door under facing for masonry

Možnost provedení: 1. obklad nad rámečkem – standardní provedení
2. obklad zapuštěný do rámečku

V objednávce nutné uvést!

1. Invisible frame (standard).
 2. Facing embedded in the frame.
- Options – necessary to indicate.



Revizní dvířka pod obklad do SDK systémů
Inspection doors under facing to drywall system

Možnost provedení: 1. obklad nad rámečkem – standardní provedení
2. obklad zapuštěný do rámečku

V objednávce nutné uvést!

1. Invisible frame (standard).
 2. Facing embedded in the frame.
- Options – necessary to indicate.



RD do bytového jádra

Řešení pro snadné přístupy do instalačních šachet.

- odnímatelný celý vnitřní rám (zámky: klička) , pro snadný přístup k celému potrubí v případě nutnosti oprav
- otevíratelná středová dvířka (zámky: US nebo klička), pro snadný přístup k uzávěrům
- možnost obložení obkladem po celé ploše vnitřního rámu
- provedení možné s deskou: GKB, GKBi, GKF, GKFi
- možnost výroby venkovního rámu s určením do zdiva, nebo SDK systému

V případě oprav potrubí, není nutno bourat zdivo apod. , pouze se vyndá odnímatelný vnitřní rám.

- výroba od větších rozměrů – NA DOTAZ

Např.: odnímatelný vnitřní rám – 2200 x 1000 mm.

Středová dvířka na pantech – libovolná velikost.

RD for bath and kitchen

Solution for easy access to installation shafts.

- removable panel (key locks), for easy access to pipes in case need for repairs
- inner flap – openable on hinges (press locks or key lock) , for easy access to faucets
- suitable for ceramic facing on whole area of the panel
- any kind of plasterboard possible: GKB, GKBi, GKF, GKFi
- outer frame could be produced for use both to drywall or masonry construction

In case of need to repair pipes, is not necessary to demolish the wall etc., you can just remove the panel.

- any dimensions possible to produce – on request

For example.: removable panel – 2200 x 1000 mm.

Inner frame on hinges – arbitrary dimensions.



RD do kazetového podhledu

- Možnost montáže:
 - upevnění pomocí šroubů z bočních stran hlavních profilů kazetového podhledu k rámu – při větším zatížení stropu:
 1. pomocí drátu s hákem k rámu dvířek (A)
 2. nebo pérového závěsu pro hl. T profil (B), kdy je nutno vybrousit drážku na venkovní straně rámu dvířek.
- Použit zámek US.
- Dodáváno bez tepelné izolace.
- Vhodná velikost:
 1. pro 3 kazety (60x60) v jedné řadě
 2. pro 6 kazet (60x60) ve dvou řadách

RD for cassette ceiling

- *Assembling options:*
 - *Mounting by screws from the side of main profiles of cassette ceiling to the door frame*
 - *For ceilings with higher load:*
 1. *Using the suspension wire with hook on the outer frame of the doors (A)*
 2. *Or Quick hanger for main runner (B), when it is necessary to grind a groove on the outer frame*
- *Used US locks*
- *Supplied without the heat insulation*
- *Suitable dimensions:*
 1. *For 3 cassettes (60x60 cm) in one row*
 2. *For 6 cassettes (60x60cm) in two rows*

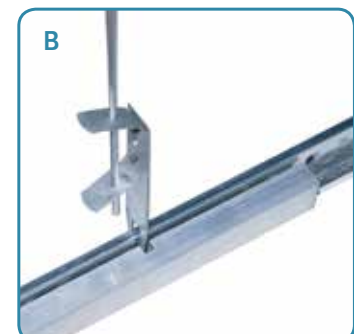
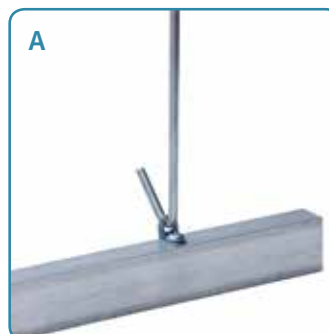

KÓTY REVIZNÍCH DVÍŘEK DO SÁDKOKARTONU

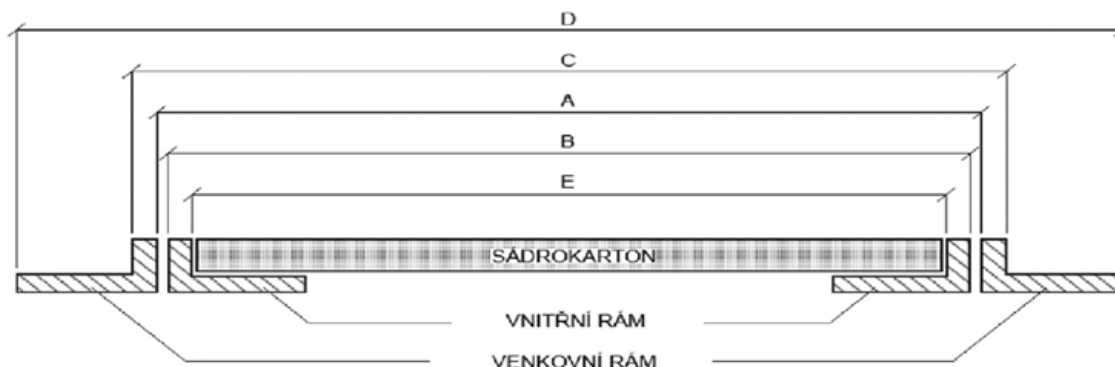

Pokud není v objednávce uvedeno jinak, standardně se dvířka vyrábějí v provedení:

- pro obyčejná dvířka platí kóta A
- pro obkladová dvířka platí kóta B.

KÓTY REVIZNÍCH DVÍŘEK PRO ZAZDĚNÍ

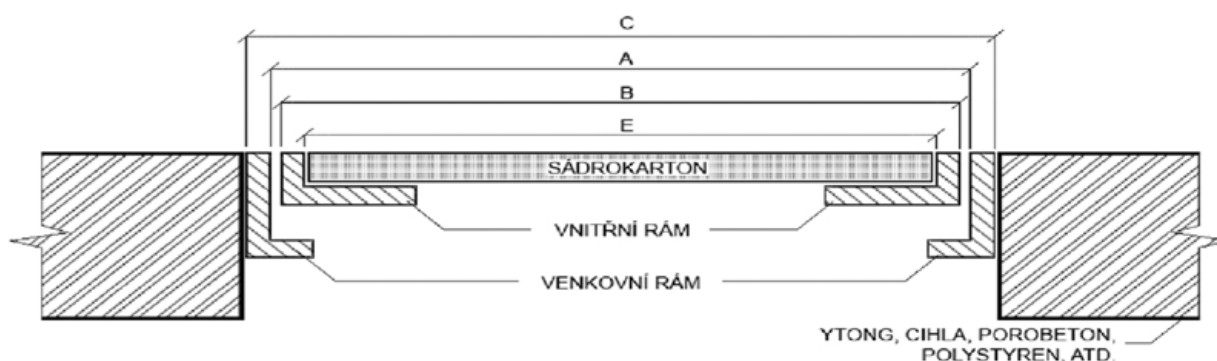

Pokud není v objednávce uvedeno jinak, standardně se dvířka vyrábějí v provedení:

- pro obyčejná dvířka platí kóta C
- pro obkladová dvířka platí kóta B.

Do objednávky revizních dvířek je vždy nutno uvést:

- rozměr – v případě nestandardní kóty, je nutné vždy uvést kótu dle výkresu
- požadovaný sádkokarton : 9,5 mm, 12,5 mm , 15 mm, 25 mm (2x12,5), 30 mm (2x15) , 36 mm (2x18)
– GKB, GKBi, GKF, GKFi, bez sádkokartonu
- typ zámku: CZ-pérkový , US-speciální tlačný , klička , FAB – možno v kombinaci s US zámkem, nebo kličkou
- u obdélníkových dvířek uvést stranu pro zámky
- u dvířek nad 60 dm² plochy uvést usazení – do stropu nebo do stěny
- jsou li dvířka určena pro obklad (u obkladu s lepidlem větším jak 8 mm uvést jeho tloušťku)
- jsou li dvířka určena pro obklad zapuštěný do rámečku (uvést tloušťku obkladu s lepidlem)
- mají-li být dvířka prachotěsná (vnitřní rámeček je vždy v provedení 12,5 mm)
- mají-li být dvířka určena pro zazdění (CIHLA, YTONG, POLYSTYREN, atd...)
- mají-li být dvířka vyndavací – bez pantu (označení KLAPKA není platný termín pro vyndavací dvířka)
- mají-li být dvířka dvoukřídlá
- všechny další nestandardní požadavky (případně po telefonické domluvě)

V případě nevyplnění podstatných údajů do objednávky se vystavujete riziku dodání nevyhovujícího výrobku a tím i neuznání reklamace!

Dimensions of revision doors for drywall

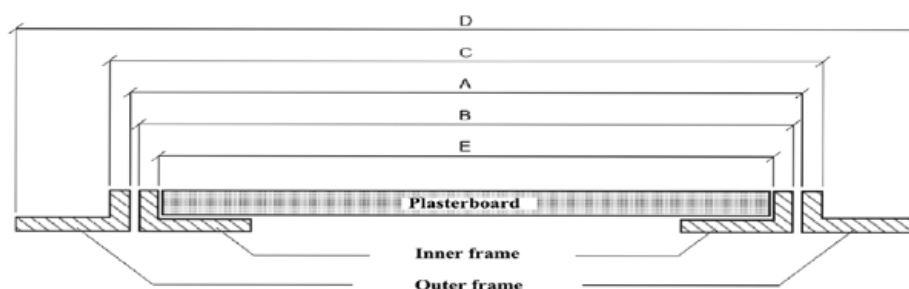

If not specified in your order, we produce standard doors according:

- Dimension A for ordinary doors
- Dimension B for doors under ceramic tiles

Dimensions of revision doors for masonry

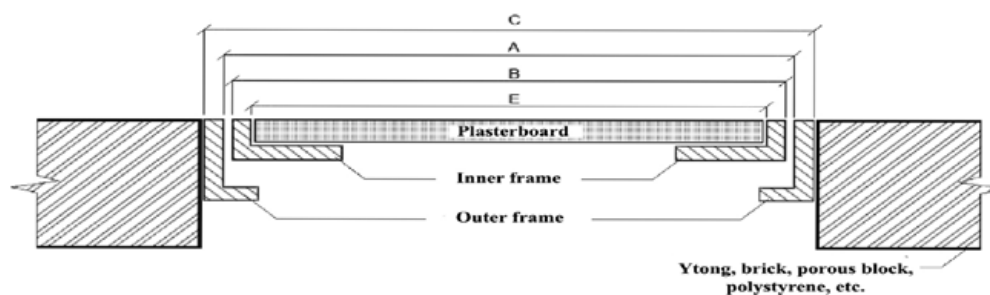

If not specified in your order, we produce standard doors according:

- Dimension A for ordinary doors
- Dimension B for doors under ceramic tiles

Important information for ordering revision doors:

- Dimensions, in case of non-standard size, we always need specified according the picture on this page
- Requested kind of plasterboard – 9,5 mm; 12,5 mm; 15 mm; 25 mm (2x12,5); 30 mm (2x15); 36 mm (2x18)
– GKB; GKBi; GKF; GKFi; without plasterboard
- Kind of lock: CZ – spring lock; US – special lock; Crank; FAB – cylindric lock (possible in combination with US or crank)
- For rectangular dimensions specify the size for locks
- For doors over 60 dm² square specify, if they are for vertical or horizontal construction
- Specify, if the doors will be in wall with ceramic tiles and if the tiles incl. the cement is over 8 mm
- If you want doors with visible frames (tiles recessed in the frame), specify the thickness of tile including the cement
- Request for dustproof (inner frame can only be with 12,5 mm board)
- Determination in masonry (bricks, porous blocks, etc.)
- Specify, if you want to have the inner flap removable. Standardly we produce the wing fixed on hinges.
- Specify, if you want double-wing doors and how to split
- Any other non-standard requests specify on the order, of by phone

In the case of omission of important specifications in your order you take a risk of non-compliant product delivery, thus disallowing eventual claim

zámek pérko - CZ
Spring locks - CZ

- při montáži dvířek nutno dbát přesného usazení.
- možnost použití u standardních a vyndavacích dvířek
- automatický / tlačný
- katalogové označení: / NZ
- need to be precisely assembled to right angle
- suitable for standard and removable doors
- automatic / press to open
- marked in product code: / NZ



zámek klička
Crank lock

- možnost použití u všech typů dvířek
- vhodný pro zabezpečení proti nežádoucímu otevření
- dvířka dodávány s jedním klíčem na zámek
- katalogové označení: / JZ
- suitable for any kind of doors
- reliable against accidental opening
- supplied with one key for each lock
- marked in product code: / JZ



zámek US
US locks

- pevnější konstrukce oproti zámku CZ
- vhodný pro dvířka určených do SDK stěn, zdiva, šachet a dvířek pod obklady
- automatický / tlačný
- katalogové označení: / SZ
- more solid construction comparing with CZ locks
- suitable for doors to vertical constructions both drywall and masonry, for shafts and doors with ceramic tiles
- automatic / press to open
- marked in product code: / SZ



zámek FAB
Lock FAB (cylindric)

- vhodný pro zabezpečení proti nežádoucímu otevření
- dvířka dodávány se dvěma klíči na zámek
- katalogové označení: FAB
- suitable to ensure unwanted access
- supplied with two keys for each lock
- marked in product code: / FAB



Alu lišta
Alu lath

1.348500T	2,0 m
1.348501T	2,5 m
1.348502T	3,0 m

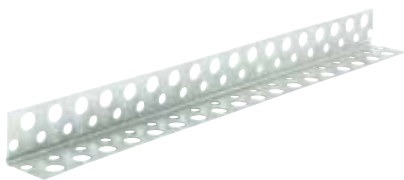

Ohebná hrana 30x34 mm
PVC flexible edge guard 30x34 mm

1.348509T	3,0 m
-----------	-------

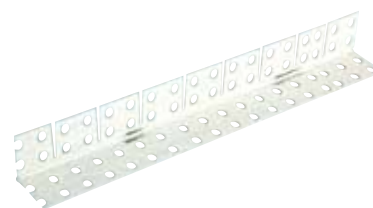

Alu lišta – 135°
Alu lath – 135°

1.348503T	3,0 m
1.348503.1T	2,5 m

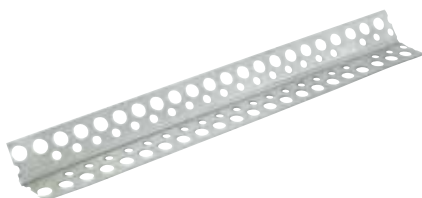

Ohebná hrana plná – minerál
Flexible perimeter profile

1.348509,1T	2,5 m
-------------	-------



Ukončovací Alu lišta 13x24 mm
Alu lath finishing 13x24 mm

1.348504T	2,5 m
1.348504,3T	3 m



Dilatační profil – šikmina
PVC Dilatation profile for sloped walls

1.348509,1T	30 m
-------------	------



Ukončovací lišta PVC
PVC finishing profile

1.348504,4T	6,0 mm/3,0 m
1.348504.1T	9,5 mm/2,5 m
1.348504.2T	9,5 mm/3,0 m
1.348505T	12,5 mm/2,5 m
1.348506T	12,5 mm/3,0 m
1.348507T	15,0 mm/2,5 m
1.348508T	15,0 mm/3,0 m



Ukončovací lišta Protektor 3750
Dilatation profile Protektor 3750

1.348509,1T	75 m
-------------	------



Ukončovací lišta PVC „h“
PVC finishing profile „h“

1.348509.2T

2,5 m

Ukončovací lišta PVC „F“
PVC finishing profile „F“

1.348509.2,1T

2,5 m



Poznámky:

Natloukací hmoždinka

(pro upevnění nosných profilů UW,UD a CW)

Nail plug (for fitting the UW,UD and CW profiles) *bal/pac*

1.348800.01T	6x25 mm	200
1.348800T	6x35 mm	100
1.348801T	6x40 mm	100
1.348802T	6x45 mm	100
1.348803T	6x55 mm	100
1.348804T	6x60 mm	50
1.348805T	6x70 mm	50
1.348805.00T	6x80 mm	50
1.348805.01T	8x45 mm	50
1.348805.02T	8x60 mm	50
1.348805.02.16T	8x75 mm	50
1.348805.03T	8x80 mm	50
1.348805.04T	8x100 mm	50
1.348805.05T	8x120 mm	50
1.348805.05.18T	8x135 mm	50



Kotevní trn ze slitiny (HKH)

Anchor nail (alloy) (HKH)

bal/pac

1.348807T	6x30 mm	100
1.348808T	6x40 mm	100
1.348809T	6x50 mm	100



Rozevřací hmoždinka (do dutých prostorů)

Cavity plug

bal/pac

1.348811T	KU 12 - HRD	50
1.348812T	KU 19	50



Stropní trn DN6 (HKN)

(pro připevnění závěsů do betonové nosné konstrukce)

Ceilling nail DN 6 *bal/pac*

1.348806.1T	100
-------------	-----



Speed Kov

SPEED metal

bal/pac

1.348812.1T	100
-------------	-----



Stropní trn ZHOP

(pro připevnění závěsů do betonové nosné konstrukce)

Ceilling nail ZHOP *bal/pac*

1.348806.1,2T	6x35 mm	100
1.348806.2T	6x45 mm	100
1.348806.3T	6x55 mm	100



Šneková hmoždinka TUR-N speed

(pro upevnění drobných předmětů do sádkartonu)

Worm plug (for fixing small object to plasterboard) *bal/pac*

1.348813T	Speed - plast	100
-----------	---------------	-----

Šneková hmoždinka TUR špička speed (SKH)

Worm plug-tip (for fixing small object to plasterboard) *bal/pac*

1.348814T	TDK - plast	100
-----------	-------------	-----

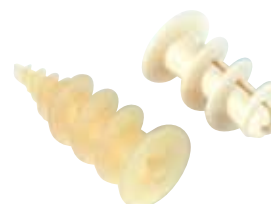

Usazovací nástavec pro SPEED
Plastic setting socket for SPEED

1.348814.1T



HOD-S hmoždinka do ocelových dutin
HOS-S Steel cavity plug

bal/pac

1.348900, T	8x21 M4	100
1.348900,1 T	8x32 M4	100
1.348901 T	8x38 M4	100
1.348901.1 T	8x54 M4	50
1.348902 T	10x65 M5	50
1.348902.1 T	10x52 M5	50
1.348903 T	12x65 M6	25
1.348904 T	12x52 M6	25



KEW ND natloukací hmoždinka
KEW ND nail plug

bal/pac

1.348805.06 T	6x35	50
1.348805.07 T	6x40	50
1.348805.08 T	6x50	50
1.348805.09 T	6x60	50
1.348805.10 T	6x75	50
1.348805.10,1 T	6x80	50
1.348805.11 T	8x60	50
1.348805.12 T	8x80	50
1.348805.14 T	8x100	50
1.348805.15 T	8x120	50
1.348805.151 T	8x140	50
1.348805.18 T	8x160	50



HSD-O Hmoždinka do ocelových dutin – oko
HSD - Steel cavity plug (eye)

bal/pac

1.348910 T 25

HSD-C Hmoždinka do ocelových dutin – hák
HSD - Steel cavity plug (hook)

bal/pac

1.348911 T 25

HSD-S Hmoždinka do ocelových dutin – šroub
HSD - Steel cavity plug (screw)

bal/pac

1.348912 T 25

HSD-M Hmoždinka do ocelových dutin – matice
HSD - Steel cavity plug (nut)

bal/pac

1.348912,1 T 25



UH – hmoždinka uzlovací
UH – Plug for hollow spaces

bal/pac

1.348913 T 6x37 100

1.348913,1 T 6x51 100

1.348914 T 8x50 100

1.348915 T 10x60 100



UPP – hmoždinka obyčejná
UPP plastic dowel

1.348916.1 T 8x40

1.348916.2 T 10x50



KEW-KHD 10 – hmoždinka do dutin

KEW-KHD 10 Cavity plug

bal/pac

1.348810 T	10x50	100
------------	-------	-----



Samořezný šroub TN – jemný závit

Drywall screw – fine thread TN

1.348815.3T	TN 25 - 3,5x25
1.348816.3T	TN 35 - 3,5x35
1.348817.3T	TN 45 - 3,5x45
1.348818.3T	TN 55 - 3,5x55
1.348819T	TN 70 - 4,2x70
1.348819.2T	TN 80 - 4,2x80
1.348820T	TN 90 - 4,2x90



HPK-C Hmoždinka plastová HÁK

HSPK-C plug - hook

1.348917.1 T	8x40 M4
--------------	---------

HPK-O Hmoždinka plastová OKO

HSPK-C plug - eye

1.348917.2 T	8x40 M4
--------------	---------

HPK-S Hmoždinka plastová ŠROUB

HSPK-C plug - screw

1.348917.3 T	8x40 M4
--------------	---------

HPK-L Hmoždinka plastová SKOBA

HSPK-C plug – hooked nail

1.348917.4 T	8x40 M4
--------------	---------



Samořezný šroub TX – hrubý závit

Drywall screw – coarse thread TX

1,348821T	TX 35 - 3,5x35
1,348822T	TX 45 - 3,5x45
1,348823T	TX 55 - 3,5x55
1,348824T	TX 65 - 3,9x65
1,348825T	TX 75 - 4,2x75
1,348826T	TX 90 - 4,2x90



Samořezný šroub Excelent TN

Excellent drywall screw – fine thread TN

1,348815.3 E	3,5x25
1,348816.3 E	3,5x35



Natloukací hmoždinka TOTAL FIX

TOTAL FIX nail plug

bal/pac

1.348805.16,1 T	6x40	200
-----------------	------	-----



Samořezný šroub TN

Drywall screw - fine thread TN

ks/psc

1.348814.3,1 T	TN 25 – 3,5x25	100
1.348814.3,3 T	TN 35 – 3,5x35	100
1.348814.3,4 T	TN 45 – 3,5x45	100
1.348814.3,5 T	TN 55 – 3,5x55	100

Vrut s vrtací špičkou

Self drilling drywall screw

1.348830 T	TB 25
1.348831 T	TB 35
1.348832 T	TB 45
1.348832.1 T	TB 55

Samořezný šroub TX

Drywall screw - coarse thread TX

ks/psc

1.348821.1 T	TX 35 – 3,5x35	100
1.348821.1.2 T	TX 45 – 3,5x45	100
1.348821.1.3 T	TX 55 – 3,5x55	100

Samovrtané šrouby TEX

(pro montáž ocelových profilů)

Self drilling screw TEX

ks/psc

1.348833 T	TEX 3,5x9,5	100
1.348834 T	TEX 3,5x9,5	1000
1.348835 T	TEX 4,2x13	1000
1.348836 T	TEX 4,2x16	1000
1.348837 T	TEX 4,2x19	1000

Šroub do dřeva s rámovou hlavou – závit TX

FN Frame head screw (for wood)

1.348827 T	FN 4,2x35
1.348828 T	FN 4,2x45
1.348829 T	FN 4,2x55

Samovrtané šrouby TEX s rámovou hlavou

Self drilling screw TEX - frame head

ks/psc

1.348827.3 T	TEX 4.2x13	1000
1.348827.4 T	TEX 4.2x19	1000
1.348827.2 T	TEX 4.2x25	1000



Samořezný šroub TX – GKB+GKB
Self-tapping screw TX GKB+GKB

1.348829,9 T

5,5x38



Samořezný šroub – P TN pásek
Drywall screw – fine thread TN – Collated

1.348820

3,5 x 25

Samořezný šroub – P TN pásek
Drywall screw – fine thread TN – Collated

1.348820.35

3,5 x 35



Vrut samořezný Cetris
Screw for cement-bonded particleboards

1.348839.2 T

4,2x25

1.348839.3 T

4,2x35

1.348839.4 T

4,2x45

1.348839.5 T

4,2x55



LN Sharp
LN Sharp

1.348827.11 LN

3,5x11



Poznámky:

TTH – talířová hmoždinka
TTH – plate dowel

1.348920T	10/60–70
1.348921T	10/60–90
1.348922T	10/60–110
1.348922,5T	10/60–120
1.348923T	10/60–130
1.348923,5T	10/60–140
1.348924T	10/60–150
1.348924,5T	10/60–160
1.348925T	10/60–170
1.348925,5T	10/60–180
1.348926T	10/60–190
1.348926,5T	10/60–210
1.348927,526T	10/60–260



Sklotextilní mřížka VERTEX
fiberglass mesh VERTEX

3.1051	R 117	55 m ²
3.1052	R 131	55 m ²

Sklotextilní mřížka 145 g
fiberglass mesh

3.1053	50 m ²
--------	-------------------



Talířová podložka
Plate washer

3.1045	pr. 60 mm
--------	-----------



PVC roh + síťka TOP
Edge protection PVC profile with mesh

3.1063	10 x 10 cm – 2,5 m
--------	--------------------

PVC roh + síťka VERTEX
Edge protection PVC profile with mesh VERTEX

3.1062 VERTEX	10 x 10 cm – 2,0 m
3.1063 VERTEX	10 x 10 cm – 2,5 m



Talířová podložka TIT
Plate washer TIT

3.1046	40/6 mm
3.1046/60	60/5 mm



Al roh + síťka TOP

Edge protection ALU profile with mesh

3.1068	10 x 10 cm – 2,5 m
--------	--------------------

Al roh + síťka VERTEX

Edge protection ALU profile with mesh VERTEX

3.1067	10 x 10 cm – 2 m
--------	------------------

3.1068 VERTEX	10 x 10 cm – 2,5 m
---------------	--------------------



Podložka pro zakládací profily

Plastic chock for socket profiles

3.1211	3 mm
--------	------

3.1212	5 mm
--------	------

3.1213	10 mm
--------	-------

3.1214	8 mm
--------	------



Zakládací profil

Base profile

3.1082	20 – 0,6 mm x 2 m
--------	-------------------

3.1083	30 – 0,6 mm x 2 m
--------	-------------------

3.1084	40 – 0,6 mm x 2 m
--------	-------------------

3.1085	50 – 0,6 mm x 2 m
--------	-------------------

3.1086	60 – 0,6 mm x 2 m
--------	-------------------

3.1087	70 – 0,6 mm x 2 m
--------	-------------------

3.1088	80 – 0,6 mm x 2 m
--------	-------------------

3.1110	100 – 0,7 mm x 2 m
--------	--------------------

3.1112	120 – 0,7 mm x 2 m
--------	--------------------

3.1144	140 – 1 mm x 2 m
--------	------------------

3.1146	160 – 1 mm x 2 m
--------	------------------

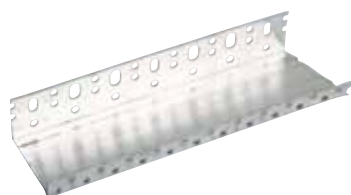

PVC balkonový profil s mřížkou VLT – 2 H

PVC balcony profile with mesh

3.1220	2,5 m
--------	-------

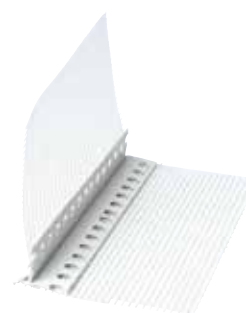

PVC okenní profil s mřížkou

Plastic window fitting profile with mesh

3.1225	6 mm	2,4 m
--------	------	-------

3.1225,5	9 mm	2,4 m
----------	------	-------

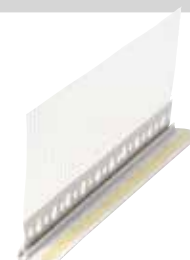

Spojka zakládacího profilu

Elongation part for socket profiles

3.1210	30 mm
--------	-------



PVC flexibilní roh LK Box

PVC flexible profile LK BOX

3.1230	10 x 10 cm/25 m
--------	-----------------



PVC LT plastový okenní profil
PVC LT plastic window profile

3.1231 2 m



Parotěsná fólie 110 g
Vapor barrier foil 110 g

3.2201 75 m²



Geotextilie
Geotextile

3.2101	150 g/2 m
3.2102	200 g/2 m
3.2103	300 g/2 m



Difuzní fólie 110 g
Diffuse foil

3.2221 75 m²



Parotěsná fólie s AL vrstvou – light
Vapor barrier + Al foil light

3.2211 75 m²



Kontaktní membrána Noroc 135 g
Contact membrane 135 g

3.2231



Poznámky:

Rychloomítník
Plaster lath

3.2041	6 mm / 3,0 m
3.2043	10 mm / 3,0 m
3.2045	13 mm / 3,0 m



Omítkový roh kulatý 34 x 34 mm
Plaster corner - rounded 34 x 34mm

3.2022	3,0 m
--------	-------



Omítkový roh pro porobeton 32 x 32 mm
Plaster corner for Aerated blocks

3.2031	3,0 m
--------	-------



Omítkový roh ostrý 34 x 34 mm
Plaster corner - sharp 34 x 34 mm

3.2011	2,75 m
3.2012	3,0 m

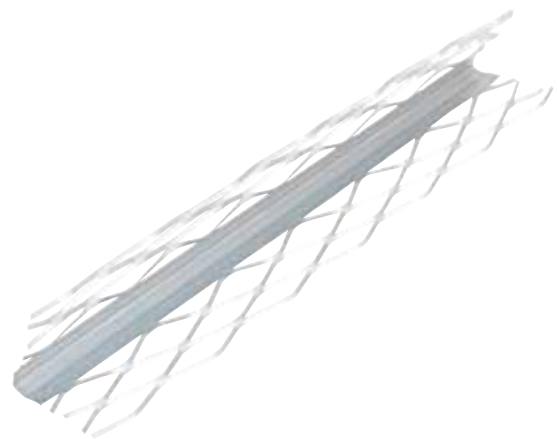

Poznámky:

Skelná páska SG
Glass fibre tape

1.348600T	25 m
-----------	------



Samolepící mřížka

Fast tape - self-adhesive

1.348601T	20 m
1.348601.1T	45 m
1.348602T	90 m
1.348602.1T	153 m



Samolepící mřížka FIBA TAPE

Self-adhesive FIBA TAPE

1.348602.2T	20 m
1.348602.3T	45 m
1.348602.4T	90 m



Pěnové těsnění

Foam rubber seal tape

1.348603T	30 mm x 30 m
1.348604T	45 mm x 30 m
1.348605T	65 mm x 30 m
1.348606T	90 mm x 30 m



Alu páska pokovená

Al adhesive tape - aluminized

1.348606,1T	50 mm x 50 m
1.348606,2T	50 mm x 100 m
1.348606,4T	100 mm x 50 m

Alu páska čistý hliník

Al tape pure aluminum

1.348606.3T	50 mm x 50 m
-------------	--------------



Krepová páska

Paper tape

1.348607T	30 mm x 50 m
1.348608T	38 mm x 50 m
1.348608,12T	50 mm x 50 m



Maskovací páska odolná UV

Masking tape - UV resistant

1.348608.1T	30 mm x 33 m
1.348608.2T	38 mm x 33 m
1.348608.3T	48 mm x 33 m



Oboustranná lepicí páska
Sticky tape - both-side

1.348610T	50 mm x 50 m
1.348611T	50 mm x 25 m
1.348614T	25 mm x 50 m
1.348615T	25 mm x 25 m



Fixační folie ruční
Stretch foil

1.348616T	23 µm - 0,5 x 150 m
1.348616.1T	20 µm - 0,1 x 150 m



Alux páska - papír s pozinkovanou páskou
Alux tape - paper + steel strips

1.348509.5 T	48 mm x 30,4 m
--------------	----------------



Rokofinal DUO
Rokofinal DUO (final paste)

1.348650TD	5 kg
1.348651TD	15 kg



Páska Straitflex Original
Tape Straitflex Original

1.348509.7 O	30,5 bm
--------------	---------



Rokofinal
Rokofinal (final paste)

1.348650T	5 kg
1.348651T	15 kg



Páska Straitflex Medium
Tape Straitflex Medium

1.348509.7 M	30,5 bm
--------------	---------



Rokoplast
Rokoplast (dry binder)

1.348651,5T	2 kg
1.348652T	5 kg
1.348653T	20 kg



Tmel Planfix „B“
Joint filler Planfix „B“

1.348659.1T	5 kg
1.348659.12	25 kg



Uniflot
Uniflot

1.348656T	5 kg
1.348657T	25 kg



Sheetrock Ap
Sheetrock Ap

1.348660T	28 kg
-----------	-------



Tmel Planfix
Joint filler Planfix

1.348659.13T	5 kg
1.348659.14	25 kg



Akrylový tmel
Acryl binder

1.348658T	280 ml
-----------	--------



CM-P Polyester
CM-P Polyester

1.348805.22T

280 ml



Lepidlo TRIM-TEX 947 – spray
Glue trimtex, spray

1.348509.4,2T

454 g



Dlažba paving

Terč pod dlažbu bez přepážky
Rubber butt under pavemant

1.348630



Terč pod dlažbu s 5 mm přepážkou
Rubber butt under pavemant

1.348632



Tužka tesařská
Timber pencil

1.348752T



Špachtle nerez + bit modrá
Spatula stainless + Bit (blue)

1.348701.1T

Špachtle nerez + bit žluto-černá
Spatula stainless + Bit (yellow-black)

1.348701.2T



Kleště na děrování profilů
Pliers for punching profiles

1.348451T



Špachtle nerez
Spatula stainless

1.348702T	150 mm
1.348703T	200 mm
1.348703.1T	250 mm



Brusná mřížka
Abrasive grating

1.348700T		120 zr
1.348700.2T		100 zr
1.348700.3T		80 zr
1.348700.4T	šířka 115 mm	100 zr



Špachtle nerez
Spatula stainless

1.348705T	40 mm
1.348707T	60 mm
1.348708T	75 mm
1.348709T	100 mm



Držák brusné mřížky žlutý – 80x225
Handle for abrasive grating-yellow

1.348701T

Držák brusné mřížky bílý – 80x225
Handle for abrasive grating-white

1.348701,1T



Hladítko nerez PROFI
Glazer stainless

1.348710T 130 x 280mm



Rašple na sádrokarton – velká
Plane standard

1.348711T



Náhradní nože do hoblíku – VARIO
Spare blade for plane VARIO

1.348712.2T



Náhradní list-rašple
Spare sheet for plane

1.348711.1T



Nůž odlamovací kovový
Knife – metal

1.348713T

18 mm



Rašple na sádrokarton – malá
Plane small

1.348712T



Nůž EXPERT celokovový
Knife metal EXPERT

1.348713.1T

18 mm



Hoblík na srážení hran – VARIO
Plane VARIO (for plasterboard cutting edges)

1.348712.1T



Nůž odlamovací plastový
Knife – plastic

1.348714T

18 mm



Náhradní nůž odlamovací B-18
Spare knife B-18

1.348714.1T



Rohová vyhlazovací lžíce – vnější
Outer corner spatula

1.348717T



Náhradní čepel oboustranná
Spare blade – both sides

ks/pcs

1.348714.2 T

10



Pilka na sádkokarton
Plasterboard saw

1.348718T



Stěrka nerez (vymazávačka)
Spatula stainless

1.348715T	60 mm
1.348715.2T	80 mm
1.348715.3T	100 mm



Struhák (pilka vrtací)
Plasterboard grater

1.348719T



Rohová vyhlazovací lžíce – vnitřní
Inner corner spatula

1.348716T



Pila vykrúžovací
Circle saw

1.348720T	25/35/52 mm
1.348721T	60/67/74 mm



Míchadlo kruh pozinkované
Mixer

1.348724T	80 x 500
1.348725T	100 x 500



Navíječ + pudr 60 g
Chalk line reel + powder 60 g

1.348730T



Šroubovací nástavec Bit PH 2 zvoneček
Bit special

1.348726T



Navíječ standard – kov
Chalk line reel – metal

1.348730.1T

Navíječ standard – plast
Chalk line reel – plastic

1.348730.2T 30 m



Nástavec magnet pro Bit
Magnetic adapter

1.348726.1T

Utahovací hrot PH2 – 25 mm Bit
Tightening pike PH 2 – bit

1.348726.2T



Náplň – pudr 100 g
Spare chalk

1.348731T



Makita elektrický šroubovák 6821
Electric screwdriver Makita

1.348728T



Sponkovačka kovová
Metal clipper

1.348732T 4– 14 mm



Spony
Spare clips

1.348733T	8 mm
1.348733.2T	12 mm
1.348733.3T	10 mm



Svinovací metr
Rolling meter

1.348736T	2 m
1.348737T	3 m
1.348738T	5 m



Vytlačovací pistole rámová
Tube press

1.348734T

Vytlačovací pistole – profi
Press gun – profi

1.348734.2T



Plastová vanička na tmel
Plastic tank for joint filler

1.348739T



Pistole pro montážní pěnu
Gun for assembling foam

1.348734.3T



Vanička nerez
Stainless tank

1.348739.1T 340 x 80 mm



Ruční nůžky na plech – rovné
Sheet scissors both side

1.348735T

Ruční nůžky na plech – P
Sheet scissors – right

1.348735.1T

Ruční nůžky na plech – L
Sheet scissors – left

1.348735.2T



Vodováha
Water level

1.348741T	500 mm
1.348742T	800 mm
1.348743T	1000 mm
1.348744T	1500 mm
1.348745T	2000 mm

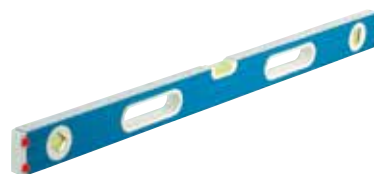

Vrták SDS
Drill SDS

1.348746.1T	6 x 100/160
1.348746T	6 x 50/110
1.348747T	8 x 50/110
1.348747,8T	8 x 260
1.348747,9T	8 x 350
1.348747.1T	8 x 100/160
1.348748T	10 x 100/160
1.348755T	10 x 210
1.348756T	10 x 310



Elektrokrabice šedá 68
Grey elektro box 68

1.348930.1,T



Elektrokrabice 64/2L
Elektro box 64/2L

1.348931T



Poznámky:

CQS - Sdružení pro certifikaci systémů jakosti
Pod Lisem 129, 171 02 Praha 8 - Troja
Česká republika

CQS je certifikačním orgánem, akreditovaným podle normy ČSN EN 45012 Českým institutem pro akreditaci, o.p.s. pod registračním číslem 3029 pro certifikaci systémů jakosti

CQS

CERTIFIKÁT

číslo: CQS 2057/2002

CQS - Sdružení pro certifikaci systémů jakosti na základě kladného výsledku certifikační prověrky prohlašuje, že systém jakosti

Miroslav Štěpán – TAMADEx
Zbečnick 348, 549 31 Hronov, Česká republika

byl prověřen a sledován v souladu s požadavky

ČSN EN ISO 9001 : 2001

Tento certifikát platí pro procesy:

- Vývoj, výroba a prodej "kovového zboží"



Platnost certifikátu omezena do: 30. 6. 2005

Datum vydání: 11. 6. 2002



Ing. Marie Šebestová
Vedoucí certifikačního orgánu



CERTIFICATE

IQNet and
CQS
hereby certify that the organization

Miroslav Štěpán – TAMADEx
Zbečnick 348, 549 31 Hronov, Czech Republic

for the following processes

- **Develop, production and sale of "Metal elements"**

has implemented and maintains a

Quality Management System

which fulfills the requirements of the following standard

ISO 9001 : 2000

Issued on: 2002 - 06 - 11

Validity date: 2005 - 06 - 30

Registration Number: **CZ - 2057/2002**



Dr. Fabio Rovarsi
President of IQNet

Vladimír Filicák
President of CQS



IQNet Partners:

AENOR Spain AFAQ France AIB-Vincotte International Belgium AFCEP Portugal CISO Italy CQC China CQM China CQS Czech Republic EQS Germany ELOT Greece PCAN Brazil FORUM/IRMA Venezuela HQQA Hong Kong ICOTEC Colombia IRAM Argentina JQA Japan KEBA Netherlands KQF Korea MSET Hungary Renko Certification Norway NSAI Ireland OQS Austria PCRK Poland PIS Certification Singapore SPS Finland SII Israel SJO Slovenia SQS Switzerland IQNet is represented in the USA by the following partners: AFAQ, AIB-Vincotte International, CISO, CQC, KEBA and NSAI

* The list of IQNet partners is valid at the time of issue of this certificate. Updated information is available under www.iqnet-certification.com



PAVUS, A.S.

AUTORIZOVANÁ OSOBA 216

autorizace č. 53/1999 ze dne 5. listopadu 1999,
ve znění autorizace č. 01/2002 ze dne 10. ledna 2002

Pražská 18, 102 45 Praha 10 - Hostivař

CERTIFIKÁT

č. C-02-158

vydaný

výrobci:

TAMADEx - Miroslav Štěpán
Zbečnick 348, HRONOV I, 549 31
IČO 13197361

na výrobek:

Servisní klapka do sádrokartonových systémů
"SKH 600 x 600"
s požární odolností EI 30 DI

U výrobku byla provedena certifikace podle ustanovení §10 zákona č.22/1997 Sb., o technických požadavcích na výrobky a o změně a doplnění některých zákonů, v platném znění.

Výše uvedená autorizovaná osoba tímto certifikátem potvrzuje, že u výrobku předmětného výrobku zůstala shoda jeho vlastností se základními požadavky nařízení vlády č. 178/1997 Sb., ve znění nařízení vlády č. 81/1999 Sb., a s technickou specifikací výrobku.

Certifikát zároveň potvrzuje, že dovozcem certifikovaného typu výrobku má zaveden systém jakosti, který zajišťuje, aby výrobky uváděné na trh odpovídaly technické specifikaci a technickým předpisům.

Tento certifikát byl vydán na základě Protokolu o certifikaci č. P - 02 - 158 ze dne 30.4.2002, kde je uvedena identifikace výrobku, závěry zjištění a podmínky platnosti certifikátu.

Tento certifikát se vydává pro účely vydání prohlášení o shodě výrobku s výše uvedenými technickými předpisy a technickou specifikací.

V Praze dne 30.4. 2002



Ing. Pavel Vaník, CSc.
generální ředitel PAVUS, a.s. - AO 216



TECHNICKÝ A ZKUŠEBNÍ ÚSTAV STAVEBNÍ PRAHA, s.p.
Technical and Test Institute for Constructions Prague

Akreditovaná zkušební laboratoř, Autorizovaná osoba, Certifikační orgán, Inspekční orgán
Accredited Test Laboratory, Authorised Body, Certification Body, Inspection Body

Autorizovaná osoba 204 podle rozhodnutí ÚNMZ č. 28/1999
Pobočka 0900 - TIS

vydává
podle ustanovení zákona č. 22/1997 Sb., o technických požadavcích na výrobky a o změně a doplnění některých zákonů, ve znění zákona č. 71/2000 Sb., a § 2 a 3 nařízení vlády č. 178/1997 Sb., ve znění nařízení vlády č. 81/1999 Sb. a s technickou specifikací výrobku České republiky

CERTIFIKÁT STAVEBNÍ TECHNICKÉ OSVĚDČENÍ

č. 090 - 006172

na výrobek:

Kovové prvky pro sádrokartonové systémy a kazetové podhledy

byjí
209TA, 209TB, 209TC, 210T, 221T, 211T, 213T, 214T, 217T, 218T, 173T, 223T, 323T,
324T, 325T, 230TMD, 231TMD, 232TMD, 212T, 234T, 225T, 336T, 332T, 331T, 233T

žadatel:

TAMADEx Miroslav Štěpán
IČ: 13197363
DIČ: 243-6912033238
adresa: Zbečnick 19, 549 31 HRONOV

výrobce: TAMADEx Miroslav Štěpán
adresa: Zbečnick 19, 549 31 HRONOV

zakázka: Z090010803

Autorizovaná osoba 204 tímto certifikátem osvědčuje údaje o technických vlastnostech výrobku, jejich úrovni a postupech jejich zjišťování ve vztahu k základním požadavkům uvedeným v příloze č. 1 nařízení vlády č. 178/1997 Sb., ve znění nařízení vlády č. 81/1999 Sb.

Osvědčení je technickou specifikací určenou k posouzení shody uvedeného výrobku.

Počet stran stavebního technického osvědčení včetně strany titulní: 4

Zpracovatel tohoto certifikátu:

Platnost osvědčení do: 16.11.2004

Osoba odpovědná za správnost tohoto STO:

Razítko autorizované osoby 204

Praha, 16.11.2001

Ing. Jiří Studnička
základní vedoucí autorizované osoby
Uzpočtení: Bez písemného souhlasu vedoucího autorizované osoby 204 se toto stavební technické osvědčení nesmí reprodukovat jinak než celé.



Ing. Zdeněk Antoš
vedoucí pozatvátel

Ing. Jiří Studnička

Provozovna/Factory:

TAMADEX

Žabokrký 50

549 31 Hronov

Czech Republic

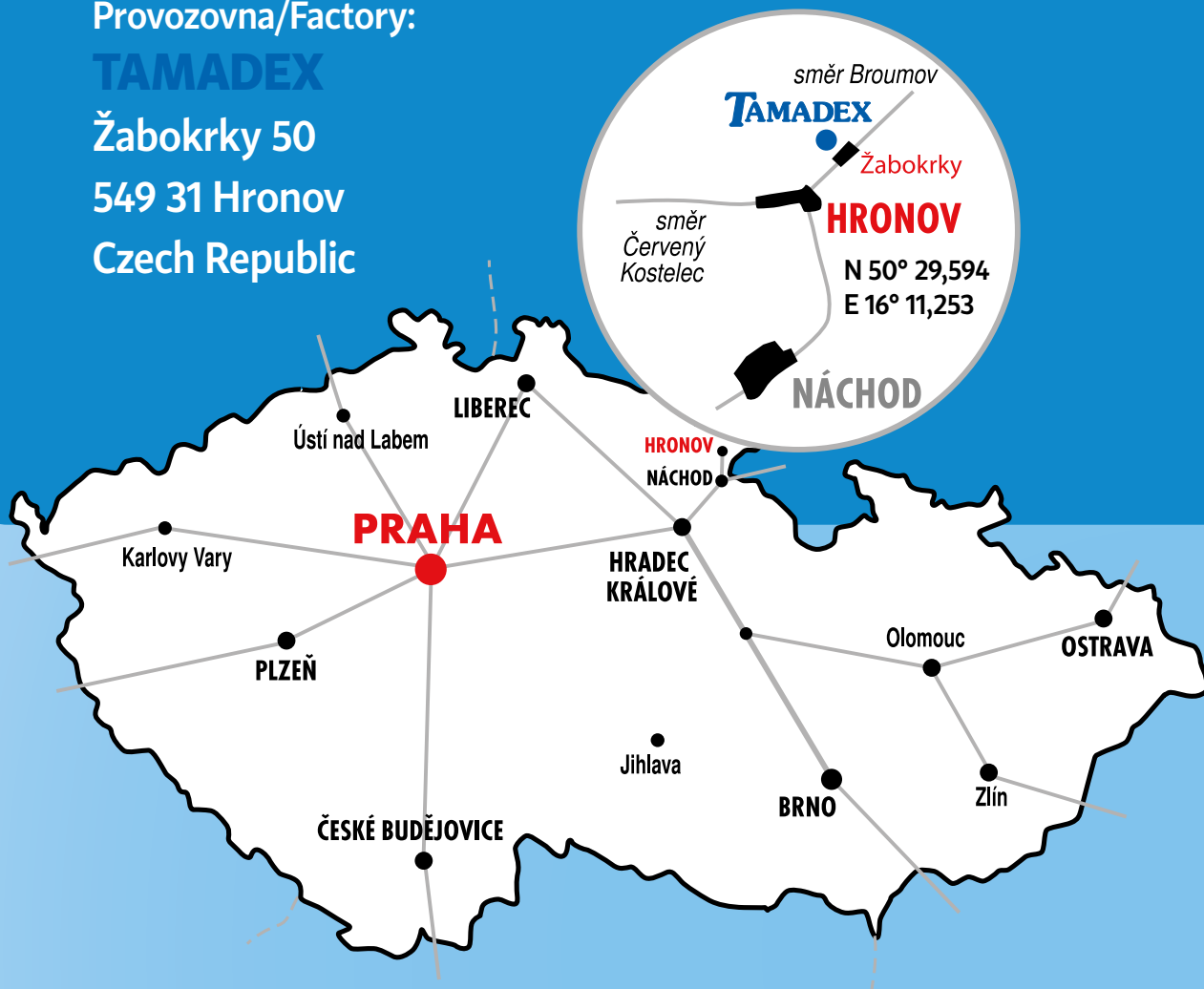

TAMADEX[®] spol. s r. o.

Zbečník 19, 549 31 HRONOV



Expedice/prodej

tel.: +420 491 481 797

fax: +420 491 543 016

mobil: +420 606 427 245

e-mail: prodej@tamadex.cz

Miroslav Štěpán st.

mobil: +420 602 219 046

Miroslav Štěpán ml.

mobil: +420 602 870 440

Klaus Bittner

mobil: +420 602 968 253

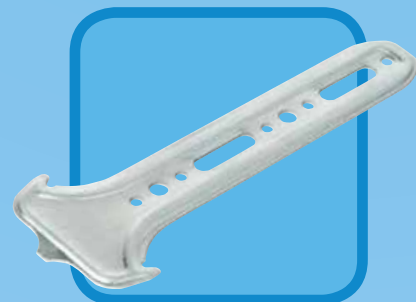

3/2013

www.tamadex.cz